



Thu Dau Mot University
Journal of Science

ISSN 2615 - 9635

journal homepage: ejs.tdmu.edu.vn



Survey transient stability of power system with penetration of wind power generation

by *Hà Văn Du* (Thu Dau Mot University)

Article Info: Received April. 7th,2021, Accepted April 25th,2022, Available online June15th,2022

Corresponding author: duhv@tdmu.edu.vn

<https://doi.org/10.37550/tdmu.EJS/2022.02.284>

ABSTRACT

Generation of electricity from wind power a renewable energy source, is continually attracting the attention of investors, researchers and electrical utilities. It has been predicted that the annual growth of wind power between 1998 and 2040 would be between 20% and 30%. This shows the increase in impact of the wind power generator to power system and the importance of understanding the behavior power wind generator following fault conditions that may develop at any point on the hosted network and consequently may affect the stability, the security as well as the quality of power system. Hence, the searching Stability of power system with connection of power wind generator is continually attracting the attention of researchers in the world. This paper displays the Surveying Stability of power system with connection of power wind generator when occurred the fault short circuit on the power system. The investigation is illustrated with network included 12 bus.

Keywords: *dynamic stability, power system, renewable energy source wind power generation*

1. Introduction

In recent years, the investment in connecting generating generator units to the distribution network, especially that using wind energy, is of prime concern due to its advantages. Due to the short construction time, relatively competitive cost compared to other types of clean energy plants ... Most wind generators use induction-type generators, it consumes reactive power under operating conditions. Normally, this can cause the voltage of the power system to drop, which is the fault of the wind power generator. The increasing

participation of wind power generating sets will change the type of power distribution and the dynamic characteristics of the power system. Therefore, the investigation of the dynamic stability of the power system with the connection of the wind power generator is an urgent issue that needs to be studied and analyzed.

This paper investigates the investigation of dynamic stability of the power system when there is the connection of a wind power generator when a 3-phase short circuit occurs on the grid. Survey based on numerical approach using PE approximation methods, the implementation tool is to build the program on M-File in Matlab Simulink. The study is illustrated with a stable survey of a grid consisting of 12 nodes including the connection of a Fix Speed wind generator. The result is the difference in the rotor speed of the wind generator, synchronous generator as well as the value of the voltage at the nodes when a 3-phase short circuit occurs at different locations on grid. From there, the conclusion is made after analyzing and evaluating the stability of the power system.

2. Mathematical models in stability survey of devices

a. Synchronous generator model:

System of differential equations synchronous generator:

$$T'_{doi} \cdot \frac{dE'_{qi}}{dt} = -E'_{qi} - (X_{di} - X'_{di})I_{di} + E_{fdi} \quad (2.1); \quad T'_{qoi} \cdot \frac{dE'_{di}}{dt} = -E'_{di} - (X_{qi} - X'_{qi})I_{qi} \quad (2.2)$$

$$\frac{d\delta_i}{dt} = \omega_i - \omega_s \quad (2.3); \quad \frac{2H_i}{\omega_s} \cdot \frac{d\omega_i}{dt} = T_{Mi} - E'_{di}I_{di} - E'_{qi}I_{qi} - (X_{qi} - X'_{qi})I_{di}I_{qi} - D_i(\omega_i - \omega_s) \quad (2.4)$$

$$T_{Ei} \frac{dE_{fdi}}{dt} = -\left(K_{Ei} + S_{Ei}(E_{fdi})\right)E_{fdi} + V_{Ri} \quad (2.5); \quad T_{Ei} \frac{dR_{fi}}{dt} = -R_{fi} + \frac{K_{Fi}}{T_{Fi}}E_{fdi} \quad (2.6)$$

$$T_{Ai} \frac{dV_{Ri}}{dt} = -V_{Ri} + K_{Ai}R_{fi} - \frac{K_{Ai}K_{Fi}}{T_{Fi}}E_{fdi} + K_{Ai}(R_{refi} - V_i) \quad (2.7)$$

$i = 1, \dots, m$: Synchronous generator

Inside:

X_d, X_q : Inductive resistance synchronous axial, horizontal axis

X'_d, X'_q : Transient inductive resistance axial, axial

R_s : Stator resistance

T'_{doi} : Axial transient time constant

T'_{qoi} : Transverse time constant across the axis

H, D : Inertia constant, friction constant

K_a, T_a : Gain and time constant in the regulator

K_e, T_e : Gain and time constant in the exciter

K_f, T_f : Gain and time constant in the feedback

ω : The speed of the rotor

b. Model of Fix Speed wind generator

System of differential equations for Fix Speed wind generator:

$$\frac{1}{\omega_s \omega_B} \frac{dE'_d}{dt} = -\frac{1}{T_0} (E'_d - (X - X')i_{qs}) + sE'_q \quad (2.8);$$

$$\frac{1}{\omega_s \omega_B} \frac{dE'_q}{dt} = -\frac{1}{T_0} (E'_q + (X - X')i_{ds}) + sE'_d \quad (2.9); \quad 2H \frac{ds}{dt} = T_e - T_m \quad (2.10)$$

$$\text{With: } T_e = v'_d i_{ds} + v'_q i_{qs} \quad (2.11); \quad T'_0 = X_r / R_r, X'_s = X_s - X_m^2 / X_r \quad (2.12)$$

X – Stator's inductive resistance

X' - Stator's transient inductive resistance

ω_s - Synchronous speed in relative unit system

ω_B - Basic sync speed

T_0 - Time constant

s - Fix speed wind generator slip.

c. Electric network model:

Includes equations for the generator node and equations for the load node. We can arrange the above equations according to real and virtual parts separately as follows:

The node equations contain synchronous generator:

$$I_{di} V_i \sin(\delta_i - \theta_i) + I_{qi} V_i \cos(\delta_i - \theta_i) + P_{Li}(V_i) - \sum_{k=1}^n V_i V_k Y_{ik} \cos(\theta_i - \theta_k - \alpha_{ik}) = 0 \quad (2.13)$$

$$I_{di} V_i \cos(\delta_i - \theta_i) - I_{qi} V_i \sin(\delta_i - \theta_i) + Q_{Li}(V_i) - \sum_{k=1}^n V_i V_k Y_{ik} \sin(\theta_i - \theta_k - \alpha_{ik}) = 0 \quad (2.14)$$

$$\text{The load node equations: } P_{Li}(V_i) - \sum_{k=1}^n V_i V_k Y_{ik} \cos(\theta_i - \theta_k - \alpha_{ik}) = 0 \quad (2.15)$$

$$Q_{Li}(V_i) - \sum_{k=1}^n V_i V_k Y_{ik} \sin(\theta_i - \theta_k - \alpha_{ik}) = 0 \quad (2.16)$$

The node equations containing a fix speed wind generator:

$$I_{di} V_i \sin(\delta_i - \theta_i) + I_{qi} V_i \cos(\delta_i - \theta_i) + P_{Li}(V_i) - \sum_{k=1}^n V_i V_k Y_{ik} \cos(\theta_i - \theta_k - \alpha_{ik}) = 0 \quad (2.17)$$

$$I_{di} V_i \cos(\delta_i - \theta_i) - I_{qi} V_i \sin(\delta_i - \theta_i) + Q_{Li}(V_i) - \sum_{k=1}^n V_i V_k Y_{ik} \sin(\theta_i - \theta_k - \alpha_{ik}) = 0 \quad (2.18)$$

3. Power distribution calculation in steady-state

Using the Newton-Raphson method to solve the nonlinear system of the power distribution equations:

$$P_i = \sum_{n=1}^N \left| \dot{U}_i \dot{U}_n Y_{in} \right| \times \cos \left(\theta_n - \theta_i + \alpha_{in} \right) \quad (3.1)$$

$$Q_i = \sum_{n=1}^N \left| \dot{U}_i \dot{U}_n Y_{in} \right| \times \sin \left(\theta_n - \theta_i + \alpha_{in} \right)$$

3.1 Synchronous generator:

In fact, reactive power Q_k of the generator is limited by the inequality: $Q_{\min,k} \leq Q_k \leq Q_{\max,k}$. If $Q_{\min,k} > Q_k$ then $Q_{\min,k} = Q_k$ or $Q_k > Q_{\max,k}$ then $Q_k = Q_{\max,k}$. Then the generator node (P, U) is treated as the load node (P, Q) and the voltage must be recalculated. Equation of power at node with generator:

$$P_{gi}(V_i) - \sum_{k=1}^n V_i V_k Y_{ik} \times \cos(\theta_i - \theta_k + \alpha_{ik}) = 0 \quad (3.2)$$

$$Q_{gi}(V_i) - \sum_{k=1}^n V_i V_k Y_{ik} \times \sin(\theta_i - \theta_k + \alpha_{ik}) = 0$$

3.2 Wind generator type Fix speed:

From the available wind speed we will deduce the output power P_e of the wind generator. From P_e we can calculate output Q_e and change it after each iteration.

The algorithm is as follows: Given the wind speed u_w we look up catalog and know P_e from the curves properties P_e and u_w .

$$as^2 + bs + c = 0 \quad (3.3)$$

With: $a = PeR_s^2(X_r + X_m)^2 + Pe(X_m X_r + X_s(X_r + X_m))^2 - |V|^2(R_s(X_r + X_m))^2$

$b = 2PeR_s R_r X_m^2 - |V|^2 R_s X_m^2$; $c = PeR_r^2(X_s + X_m)^2 + Pe(R_s R_r)^2 - |V|^2 R_s R_r^2$

We calculate the slip s and Q_e : $s = \min \left| \frac{-b \pm \sqrt{b^2 - 4ac}}{2a} \right| \quad (3.4)$

$$Q_e = \frac{[X_m X_r s^2 (X_m + X_r) + X_s s^2 (X_m + X_r) + R_r^2 (X_m + X_s)]}{[R_s R_r + s(X_m^2 - (X_m + X_r)(X_m + X_s))]^2 + [R_r (X_m + X_s) + s R_s (X_m + X_r)]^2} \quad (3.5)$$

Then we assign P_e and Q_e back to the node containing the Fix speed machine. Equation of power at the node with Fix Speed:

$$P_{ei}(V_i) - \sum_{k=1}^n V_i V_k Y_{ik} \cos(\theta_i - \theta_k - \alpha_{ik}) = 0 \quad (3.6)$$

$$Q_{ei}(V_i) - \sum_{k=1}^n V_i V_k Y_{ik} \sin(\theta_i - \theta_k - \alpha_{ik}) = 0$$

4. Stability survey problem

4.1 Calculate the first value:

Synchronous generator:

To calculate the first value for the derivative variable over time is 0 and $\omega_r = \omega_s$. After solving the power distribution, we find the power, voltage and voltage deviation angle of the synchronous generator.

$$\text{Set: } P_{Gi} = P_i - P_{Li} \text{ v\`a } Q_{Gi} = Q_i - Q_{Li}; I_{Gi} e^{j\gamma_i} = \frac{(P_{Gi} - jQ_{Gi})}{V_i e^{-j\theta_i}}$$

$$\text{With: } I_{Gi} e^{j\gamma_i} = (I_{di} + jI_{qi}) e^{j\left(\delta_i - \frac{\pi}{2}\right)}$$

To determine the first values for I_d v\`a I_q the first, we must determine the angle δ_i :

$$\delta_i = \text{angle} [(V_i e^{j\theta_i}) + (R_{si} + jX_{qi}) I_{Gi} e^{j\gamma_i}]$$

Calculating I_{di} , I_{qi} v\`a V_{di} , V_{qi} from the following formula:

$$I_{di} + jI_{qi} = I_{Gi} e^{j\left(\gamma_i - \delta_i + \frac{\pi}{2}\right)} \quad (4.1); \quad V_{di} + jV_{qi} = V_i e^{-j\left(\theta_i - \delta_i + \frac{\pi}{2}\right)} \quad (4.2)$$

From the stator equation of the synchronous generator we will find:

$$E'_{di} = V_{di} + R_{si} I_{di} - X'_{qi} I_{qi} \quad (4.3); \quad E'_{qi} = V_{qi} + R_{si} I_{qi} + X'_{di} I_{di} \quad (4.4)$$

$$E_{fdi} = E'_{qi} + (X_{di} - X'_{di}) I_{di} \quad (4.5)$$

From equations (3.4), (3.5) and (3.6) for the derivative over time equal to 0 we have:

$$V_{Ri} = (K_{Ei} + S_{Ei} + E_{fdi}) E_{fdi}; \quad R_{fi} = \frac{K_{Fi}}{T_{Fi}} E_{fdi}; \quad V_{refi} = V_i + \left(\frac{V_{Ri}}{K_{Ai}} \right)$$

Mechanical torque of the synchronous generator:

$$T_{Mi} = E'_{di} I_{di} + E'_{qi} I_{qi} + (X'_{qi} - X'_{di}) I_{di} I_{qi} \quad (4.6)$$

With: $i = 1 \dots m$: Number of synchronous generators.

Fix Speed wind generator:

calculating the first value for I_{ds} , I_{qs}

$$I_{ds} + jI_{qs} = \frac{P_{Gi} - jQ_{Gi}}{V_i^*} \quad (4.7)$$

$$\text{From the above equation we have: } I_{ds} = \text{real} \left[\frac{P_{Gi} - Q_{Gi}}{V_i^*} \right]; \quad I_{qs} = \text{imag} \left[\frac{P_{Gi} - Q_{Gi}}{V_i^*} \right] \quad (4.8)$$

Calculate E'_d v\`a E'_q :

$$E'_d = R_s i_{ds} - X'_{qs} i_{qs} + V_s \cos \theta \quad (4.9); \quad E'_q = R_s i_{qs} - X'_{ds} i_{ds} + V_s \sin \theta \quad (4.10)$$

Calculate value T_m : $T_m = T_e$ (4.11) With: $T_e = E'_{di} I_{ds} + E'_{qi} I_{qs}$

4.2 Algorithm:

Algorithm to solve the stability survey problem using PE method

PE method:

With PE method, we will solve each part individually. That means we will solve Stator's algebraic equations for generators $I_{d-q} = h(x, \bar{V})$ and the equations P, Q for electrical networks $0 = g_0(x, I_{d-q}, \bar{V})$ to find the first solution of the system of differential equations and then solve the system of differential equations of the generators $\dot{x} = f_0(x, I_{d-q}, \bar{V})$.

Algorithm Flowchart:

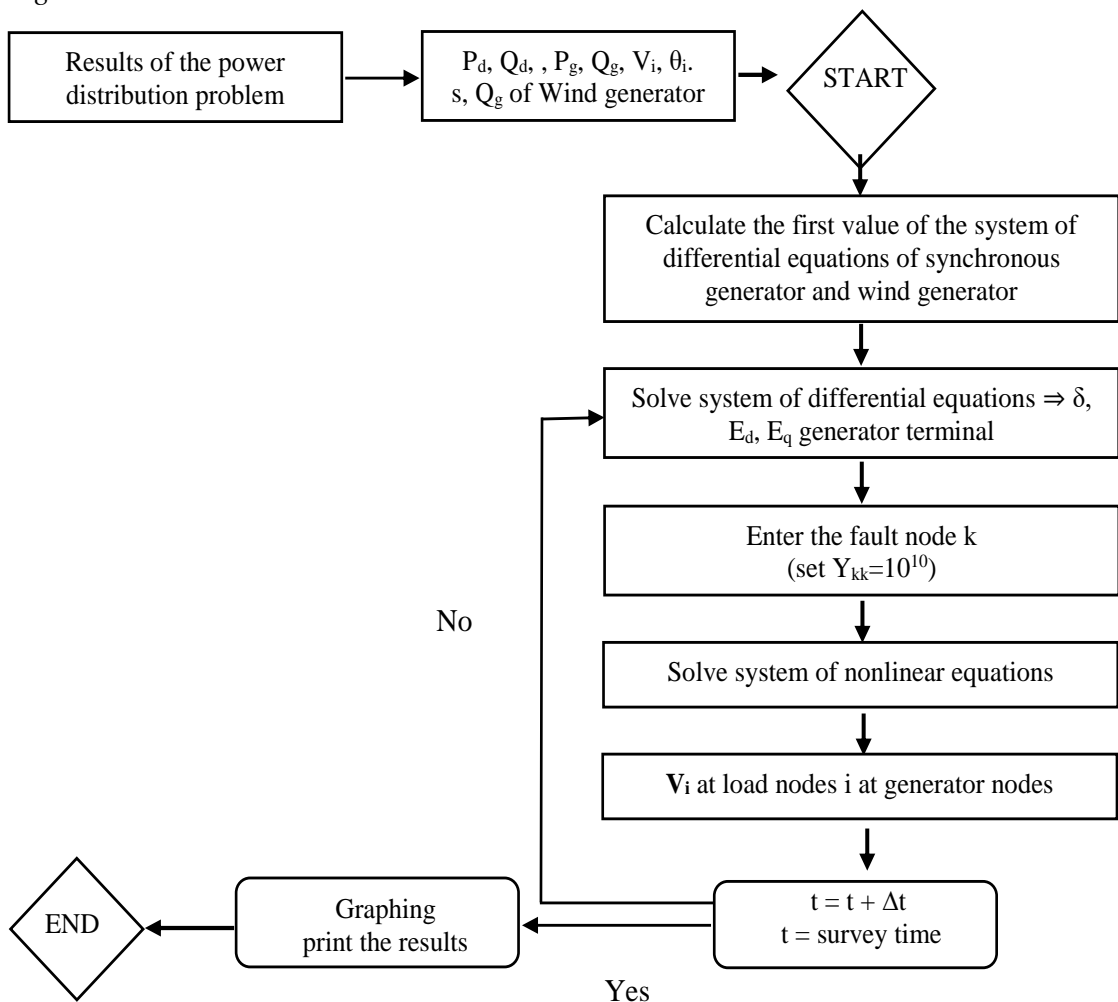

Figure 1. Algorithm Flowchart

Stable survey problem:

Surveying an electrical network consisting of 12 nodes with the connection of a generator using wind energy, load data at the nodes are shown as figure below:

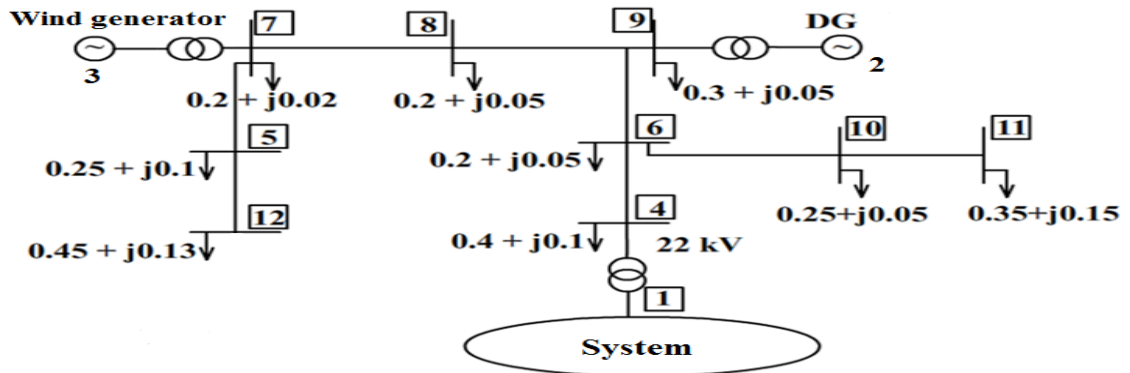

Figure 2. Electrical network connection diagram includes 12 nodes

Simulation results:

1. Create short circuit at node number 07 and for the short circuit time is 0.2s and 0.25s:
 - a. Short circuit time survey 0.2s: simulation results as figure 3 and 4.

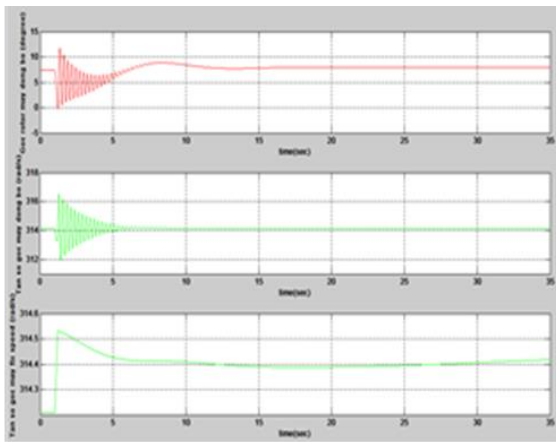

Figure 3. Rotor deviation angle, rotor speed synchronous generator and Fix speed wind generator

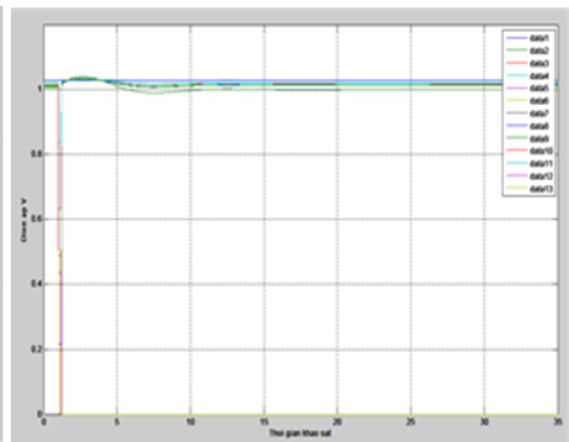

Figure 4. Voltage at the nodes

- b. Short circuit time survey 0.25s: simulation results as figure 5 and 6.

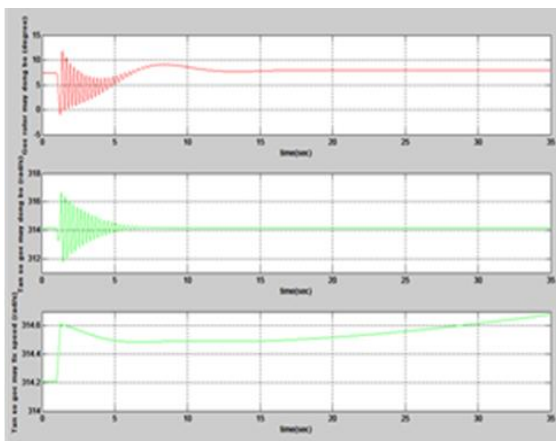

Figure 5. Rotor deviation angle, rotor speed synchronous generator and Fix speed wind generator

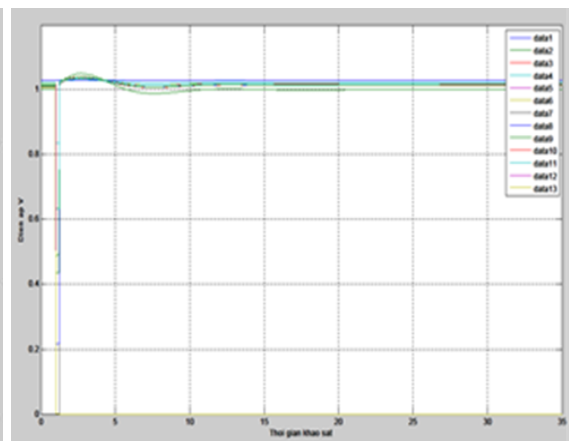

Figure 6. Voltage at the nodes

2. Create short circuit at node number 06 and for the short circuit time is 0.25s and 0.3s:
 - a. Short circuit time survey 0.25s: simulation results as figure 7 and 8

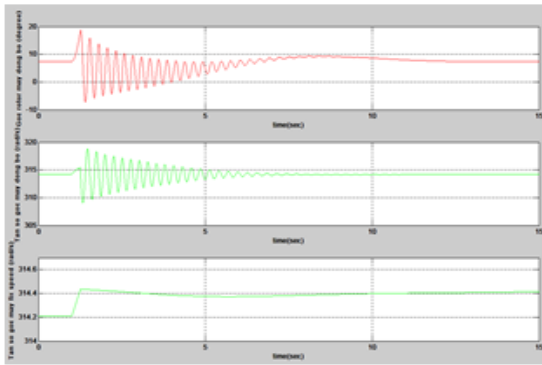

Figure 7. Rotor deviation angle, rotor speed synchronous generator and Fix speed wind generator

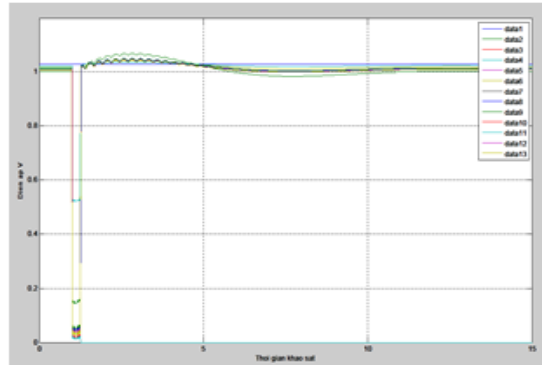

Figure 8. Voltage at the nodes

- b. Short circuit time survey 0.3s: simulation results as figure 9 and 10.

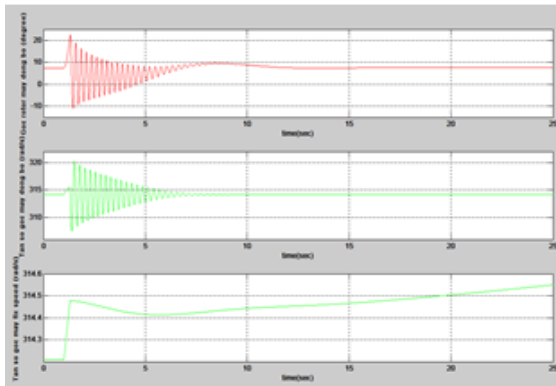

Figure 9. Rotor deviation angle, rotor speed synchronous generator and Fix speed wind generator

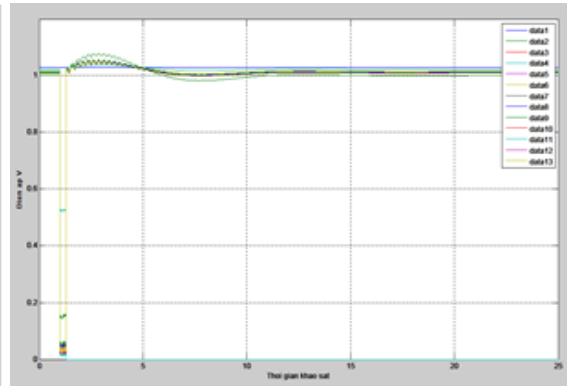

Figure 10. Voltage at the nodes

3. Create short circuit at node number 04 and for the short circuit time is 0.1s and 0.3s: simulation results as figure 11 and 12.

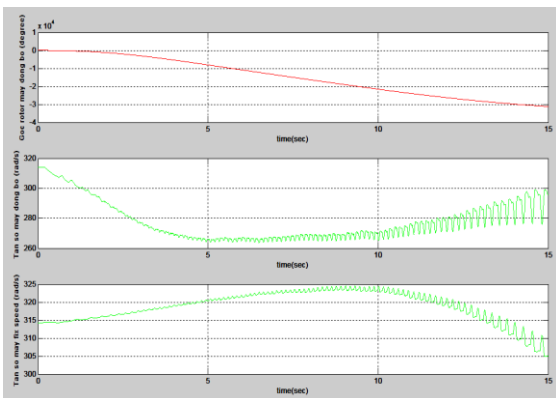

Figure 11. Rotor deviation angle, rotor speed synchronous generator and Fix speed wind generator

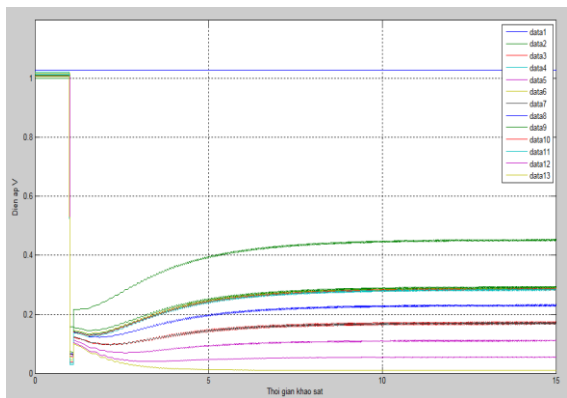

Figure 12. Voltage at the nodes

Remarks

When short-circuit at the 7-5 line (near node 07), the corner frequency of the wind machine Fix speed increases very quickly, after a period of 0.2 seconds, the short circuit is eliminated, the corner frequency drops and then stabilizes again and if the short circuit time increases to 0.25s the corner frequency continues to increase and becomes unstable. The synchronous generator is far from the short-circuit point, when the angular frequency short-circuit occurs and the rotor deflection angle decreases after a period of 0.2s and 0.25s the fault is eliminated, the angle frequency and the rotor deflection angle oscillate in a period of time and are able to stabilize again.

When short-circuit at the end of line 6-10 (near node 06), the corner frequency of the wind machine Fix speed increases, if after a period of 0.25 seconds the short circuit is eliminated, the corner frequency drops and stabilizes, if after 0.3s the short circuit is eliminated the corner frequency decreases a little and then increases and there is no possibility of stabilization again. Synchronous generator near the short-circuit point, when the angular frequency short circuit occurs and the rotor deflection angle increases after a period of 0.25s or 0.3s, the fault is eliminated, the angle frequency and the rotor deflection angle oscillate in a period of time and return to stability.

When short-circuit at the 4-1 line (near node 04), the corner frequency of the wind machine Fix speed increases, the corner frequency and the deviation angle of the synchronous generator rotor also increases, after a period of 0.1s of failure excluded, at this time the 1-4 line cut off the grid, lost the slack bus button, the capacity of the Fix speed wind generator and the synchronous generator was not enough capacity to supply the load so the corner frequency and angle Rotor deflection fluctuates greatly and decreases then becomes unstable.

5. Conclusion

With the survey based on numerical approach using approximation methods PE, the implementation tool is to build a program on M-File in Matlab Simulink. The study is built on a grid model consisting of 12 nodes and with the participation of a Fix Speed wind generator. Simulating and surveying the dynamic stability of the power system with the participation of wind generators when there is a 3-phase short circuit at different locations on the power grid. Based on the simulation results, We could found that the different changes in the rotor speed and deflection angle, the voltage value at the nodes when simulating the 3-phase short circuit at different locations on the grid. From there, we can determine the limiting tripping time at different short circuit positions to bring the power system back to stability.

References

- Fernando D. Bianchi, Hernán De Battista and Ricardo J. Mantz (2007). *Wind Turbine Control Systems*
- H. Li, Z. Chen, Senior Member, IEEE and L. Han (2008). Comparison and Evaluation of Induction Generator Models in Wind Turbine Systems for Transient Stability of Power System
- Ho Van Hien (2003). *Power Transmission and Distribution System*. Vietnam National University Ho Chi Minh City publishing house.
- J.G. Sloopweg and W.L. Kling (2002). Modelling and Analysing Impacts of Wind Power on Transient Stability of Power Systems.
- K.C. Divya, P.S. Nagendra Rao (2006). Models for wind turbine generating systems and their application in load flow studies.
- La Van Ut (2001). *Analysis and Stability control of Electrical System*. Science and technology publishing House,.
- Nguyen Hoang Viet and Phan Thi Thanh Binh (2005). *Short circuit and Stability in the Electrical System*. Vietnam National University Ho Chi Minh city publishing House.
- P. M. Anderson, A. A. Fouad (1994). *Power System Control and Stability*, 1st Edition.
- Prabha Kundur (1994). *Power System Stability and Control*.
- Pranamita Basu (2009). *Power System Stability Studies Using Matlab*.